

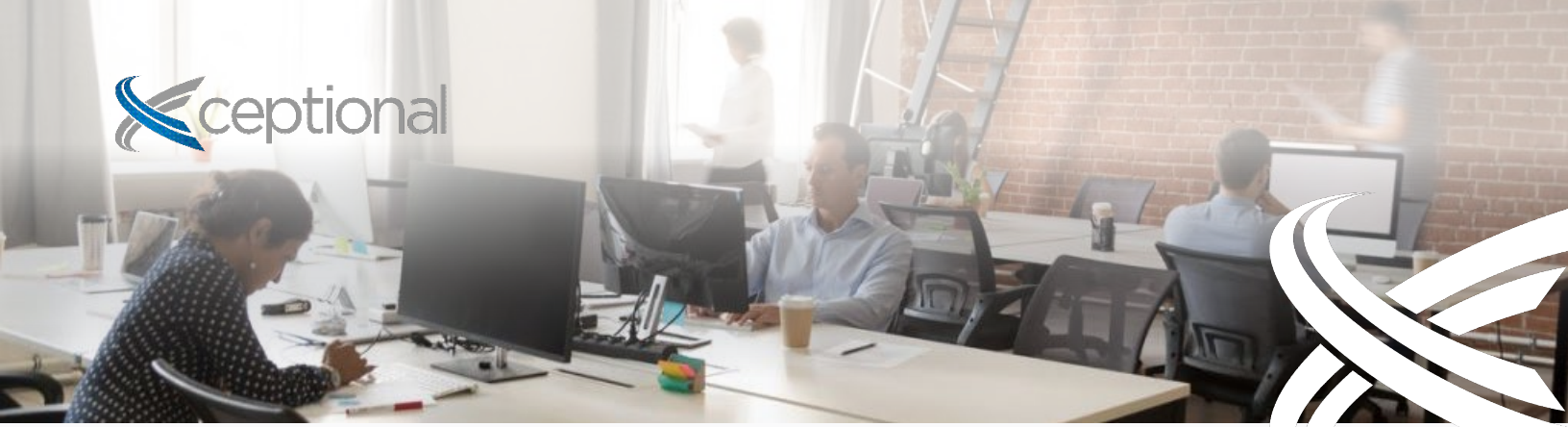

# Business Continuity & Resiliency

## Backup as a Service & Disaster Recovery as a Service Overview

Xceptional Networks  
10089 Willow Creek Road, Suite 100  
San Diego, CA 92131  
(858) 225-6230  
[info@Xceptional.com](mailto:info@Xceptional.com)



## The Business Continuity & Resiliency Imperative

The adoption of cloud technologies, increasing ransomware and cyber-attacks, along with the complexities associated with IT system, data, and application backups is causing executives to look at alternative business continuity and disaster recovery solutions. IT leaders are rearchitecting their backup infrastructure and exploring more simplified, automated, hosted, and cost-effective solutions such as Back-up-as-a-Service (BaaS) and Disaster-Recovery-as-a-Service (DRaaS).

### Market realities driving BaaS, DRaaS adoption:

- Technical Debt: Legacy or outdated IT applications, systems, or backup devices that are unstable, or cannot be updated or backed-up.
- Lack of Budget, IT Resources, Expertise: To ensure applications, systems, data sets are backed-up and are readily available in-case of an outage or cyber-attack.
- Rapid Business Change or Evolution: Sometimes business needs change too rapidly for internal IT organizations and systems to keep up. If the business expands quickly, deploys cloud, or other hosted applications and services to support clients and partners, it can create a business continuity gap if data and systems cannot be backed-up in a timely, automated manner.

*“The amount of capital, time, and energy required to keep business applications, data, and systems backed-up, and highly available incase of a cyber-attack, or outage is significant. This is where BaaS and DRaaS offerings come in.”*

*- Chris McKewon, CEO Xceptional*

## Cost Effective & Proven Solutions

Since 2007 Xceptional has helped organizations across dozens of industries with innovative, and proactive data protection, backup, and recovery solutions. We help customers to design, develop, implement and manage business continuity and disaster recovery solutions to ensure business operations can be restored incase of an emergency, cyber-attack, or IT outage.

**Xceptional’s Backup-as-a-Service (BaaS) and Disaster-Recovery-as-a-Service (DRaaS) offerings are built upon a scalable and resilient cloud infrastructure, using best-in-class data privacy, protection, and recovery technologies.** Each solution is modified to address your unique business, financial, and regulatory compliance requirements.

## Core Capabilities of Backup & Recovery Solutions - Gartner

Gartner’s view of the enterprise backup and recovery software solution market is focused on transformational technologies or approaches delivering on the future needs of end users.

Gartner suggests that the core capabilities of a backup and recovery solution should include:

- ✓ Back up and recovery operating systems, files, databases and applications in the on-premises data center.
- ✓ Create a copy of the backup in the same physical location as the production environment for the purpose of quick operational recovery.
- ✓ Assign multiple backup and retention policies that align with the organization’s recovery objectives.
- ✓ Report success and failure of backup/recovery tasks.

Additional capabilities that can be provided by the solution are:

- ✓ Create a second backup copy of on-premises backup data in the public cloud/secondary data center.
- ✓ Tier backup data to the public cloud.
- ✓ Protect public cloud IaaS, PaaS and SaaS workloads.
- ✓ Protect remote sites.

Gartner also notes that these solutions can be offered as an appliance, as software only, or as a vendor-managed service offering.

## Xceptional BaaS

**Xceptional’s Backup-as-a-Service solution utilizes award-winning technology from Veeam, that is customized to address each client’s unique recovery point objectives, and recovery time objectives while being managed and maintained by Xceptional.** This ensures business continuity and resilience while adhering to industry or federal regulations and data privacy laws. The service also reduces the risk, cost, and time associated with emergency response scenarios, business continuity and disaster recovery situations, and compliance management.

**Veeam’s ‘3-2-1-1-0’ data protection best practice ensures data is completely protected from threats of all types — even ransomware. (object lock data immutability).**

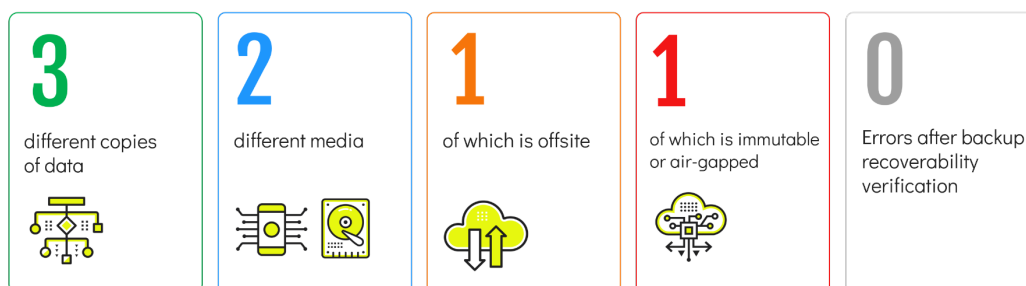

## Xceptional + Veeam + Zadara = Ransomware Prevention via BaaS

Xceptional has a long-standing relationship with Veeam a market leader in backup, business continuity and disaster recovery solutions that supports over 400K customers across the globe. To augment this relationship and ensure the Backup-as-a-Service solution is scalable, cost effective and can be delivered globally, Xceptional has also partnered with Zadara, a global innovator of cloud, IaaS, HaaS, and storage solutions.

Together, these solutions can help prevent ransomware and enforce Veeam’s 3,2,1,1,0 approach to backup and recovery and based upon how Zadara cloud environments are architected and how the copies of backup data are segmented and allocated to certain Zadara hosted environments. Learn more about how this works by [watching this webinar](#).

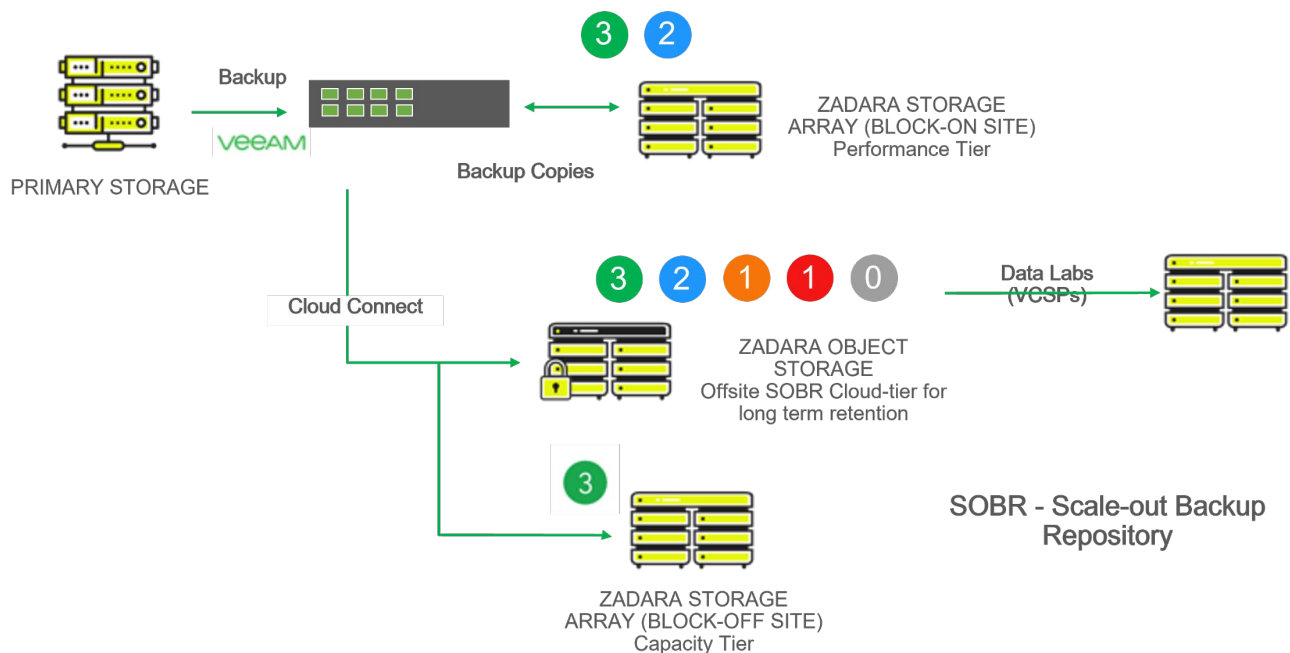

## BaaS: What’s Included

Xceptional’s Backup-as-a-Service can be purchased as an annual subscription that is invoiced monthly. This service is customized to address your unique business continuity and IT requirements and includes:

- ✓ Monthly Xceptional BaaS Subscription & Invoicing
- ✓ Veeam Backup Software Licensing
- ✓ Zadara Cloud Storage Subscription
- ✓ Cloud Compute (as needed)
- ✓ Colocation Services (as needed)
- ✓ Ongoing BaaS System Testing, Management, Maintenance by Xceptional
- ✓ Backup, Workload, Environment Dashboard, Alerting, Reporting by Xceptional

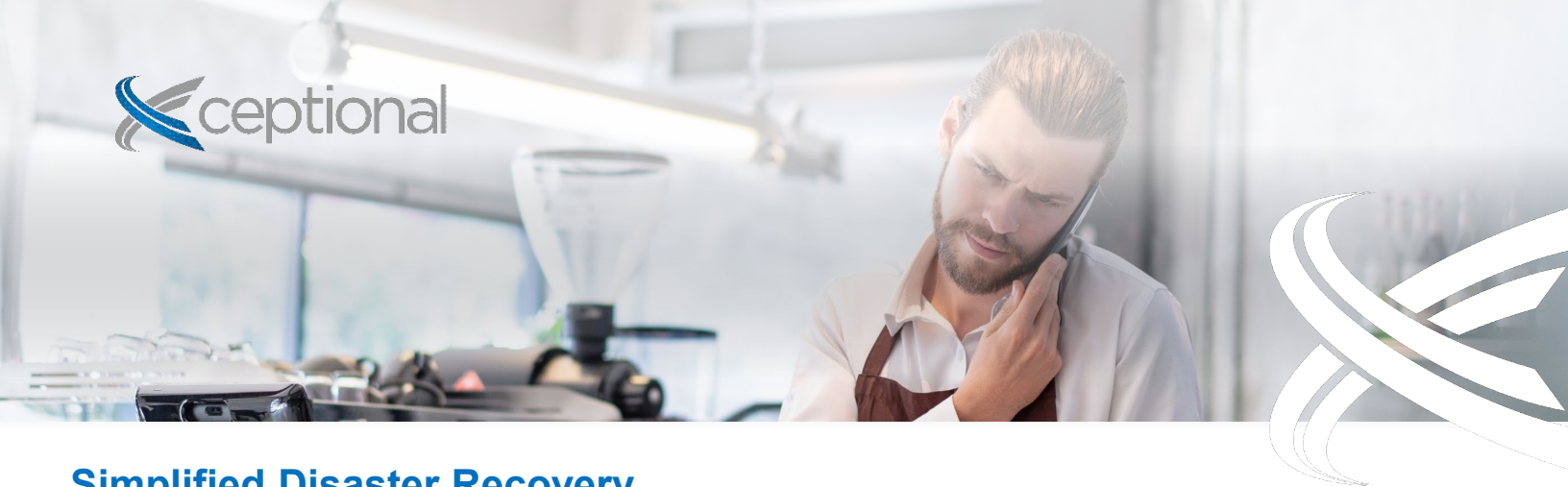

## Simplified Disaster Recovery

The journey to identify and deploy the right disaster recovery plan and technology can be long, complex, confusing, and filled with risk. The wrong technology, partner, and provider can literally cost you customers, employees, or could destroy your business or reputation if disaster strikes and your mission critical applications and systems cannot be recovered.

# 92%

of organizations expect to deliver applications and services faster through cloud services. Customer-centricity is a top priority.

- Gartner

Xceptional chose to partner with Zadara to build its Cloud, BaaS and DRaaS offerings after initially working with another global, well known cloud provider that was difficult to partner with and who's services were more costly. Zadara's worldwide network gives Xceptional customers access to a global cloud footprint. Zadara manages over 300+ clouds across six continents on behalf of its clients.

The globally distributed Zadara network enables organizations to rapidly deploy applications, storage, and workloads across distributed and secure cloud environments to achieve disaster recovery and business continuity goals and objectives.

Xceptional's approach to Disaster-Recovery-as-a-Service includes utilizing various cloud services that enable your business to operate from anywhere to anywhere - in 300 global locations on premises, at colocation facilities, service providers, and in public clouds.

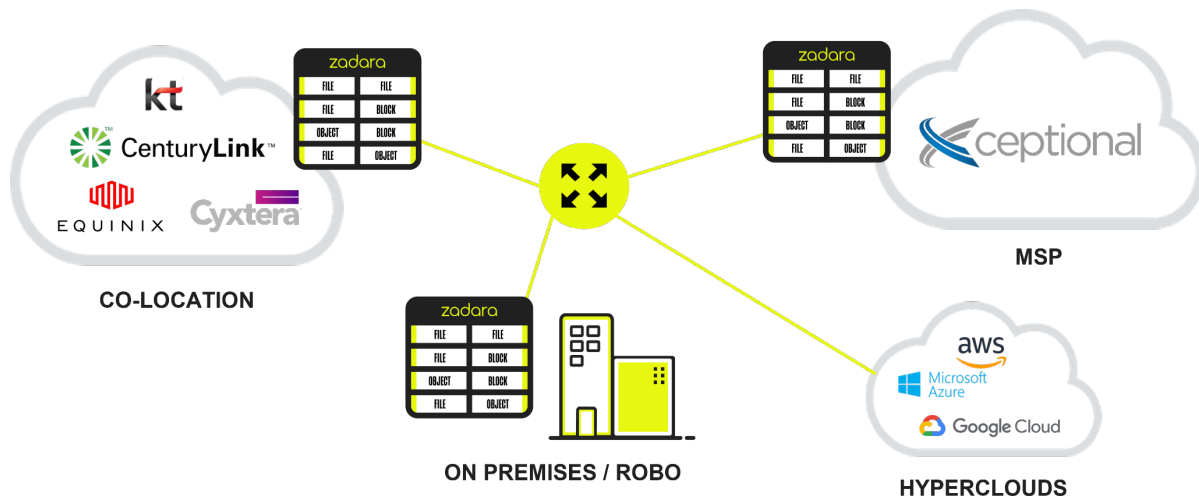

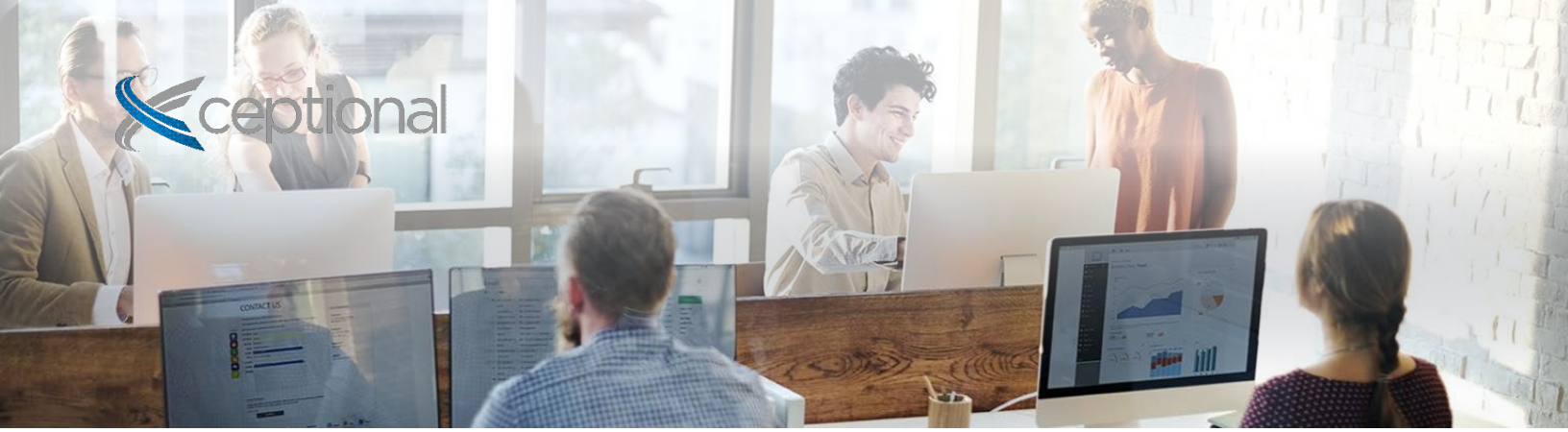

## Ensuring Business Resiliency & Accelerating Recovery

Xceptional believes that by leveraging distributed cloud and colocation environments organizations can remove a large amount of the complexity and cost associated with deploying an IT disaster recovery plan. Oftentimes, organizations are limited in terms of where they host mission critical applications, systems, and data and how and where they will replicate those systems and data to ensure those systems can be accessed in a disaster or emergency scenario.

Clients often overpay when deploying active-active or active-passive application and IT system Disaster Recovery solutions. To help enable clients with multiple cost-effective Disaster Recovery solution options, Xceptional has formed relationships with various colocation and hosting providers that will interoperate with Zadara’s cloud network across the U.S.

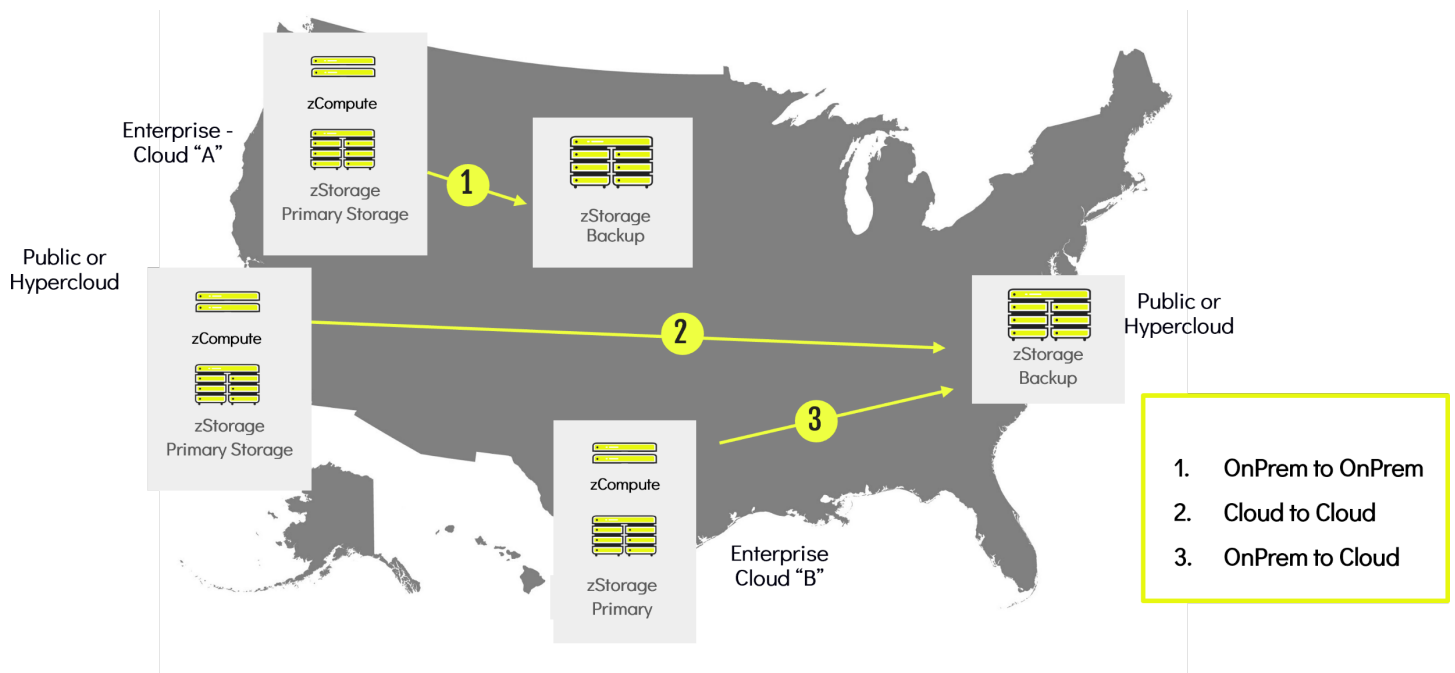

### Xceptional’s Disaster-Recovery-as-a-Service approach helps to:

- ✓ Simplify client cloud and Disaster-Recovery-as-a-Service deployments.
- ✓ Increase IT productivity while decreasing costs.
- ✓ Reduces large investments in cloud and hosting infrastructure.
- ✓ Converts CapEx storage and compute to OpEx.
- ✓ Reduces storage administration costs; scales client storage & compute up or down as needed.
- ✓ Enable clients to never overpay for unused cloud capacity.



[www.Xceptional.com/managed-it-services/](http://www.Xceptional.com/managed-it-services/)

**Contact us to learn how Xceptional can  
accelerate business continuity and resiliency  
today!**

Xceptional Networks  
10089 Willow Creek Road, Suite 100  
San Diego, CA 92131  
(858) 225-6230  
[info@Xceptional.com](mailto:info@Xceptional.com)

